

# **MPPT-DC series**

## **Solar charge controller**

### **with LED driver built-in**

(Constant Current, Boost)

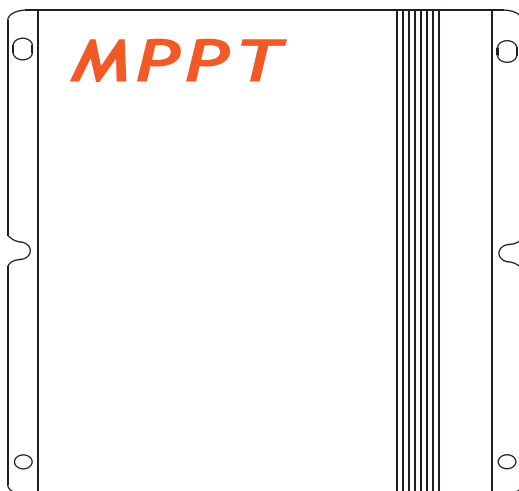

# **User Manual**

# Solar charge controller MPPT-DC series User Manual

Dear Clients,

Thanks for selecting the **MPPT-DC32** series solar controller. Please take the time to read this user manual, this will help you to take advantage of controller's new features. This manual gives important recommendations for installing, programming, using and so on. Read this user manual in full before installing or connecting the solar controller.

## 1. Description of Function

MPPT-DC32 series intelligent MPPT solar controller is programmable and especially for boost mode LED solar street light system.

It comes with some outstanding features, such as:

- Innovative MPPT technology, tracking efficiency >99%
- Full digital technology, conversion efficiency up to 93%
- Can output constant current
- 5 stages time and dimming can be adjusted
- Can read parameters and running status
- If battery voltage is low, it can be set to dimming
- Dimming start voltage and percentage can be set
- Day/Night threshold can adjust automatically
- Suitable for single Lithium battery
- Auto sleeping during transportation
- Low temperature charging protection
- When BMS power off because of LVD, it can activate the system automatically
- Charging target voltage and recovery voltage can be set
- Remote Unit to configure, with LCD display
- IP67, Strong and durable aluminum case
- Full automatic electronic protect function

## 2. Safety Instruction and Waiver of Liability

### 2.1 Safety

- ① The solar charge controller may only be used in PV systems in accordance with this user manual and the specs of other module manufacturers. No energy source other than solar gen. may be connected to the solar charge controller.
- ② Batteries store a large amount of energy, never short circuit a bat. under all circumstances. We strongly recommend connecting a fuse directly to the battery to protect any short circuit at the bat. wiring.
- ③ Batteries can produce flammable gases. Avoid making sparks, fire or any naked flame. Make sure that the bat. room is ventilated.
- ④ Avoid touching or short circuiting wires or terminals. Be aware that the voltages on special terminals or wires can be as much as twice the battery voltage. Use isolated tools, stand on dry ground, and keep your hands dry.
- ⑤ Keep children away from batteries and the charge controller.

### 2.2 Liability Exclusion

The manufacturer shall not be liable for damages, especially on the battery, caused by use other than as intended or as mentioned in this manual or if the recommendations of the battery manufacturer are neglected. The manufacturer shall not be liable if there has been service or repair carried out by any unauthorized person, unusual use, wrong installation, or bad system design.

## 3. Dimensions

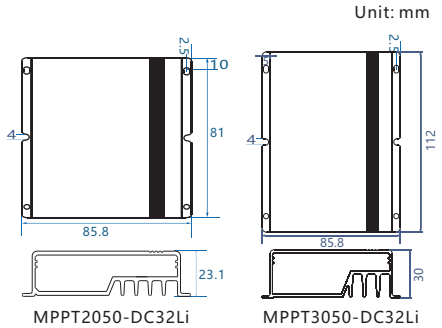

## 4. Installation

### 4.1 Connection sequence

The following diagrams provide an overview of the connections and the proper order

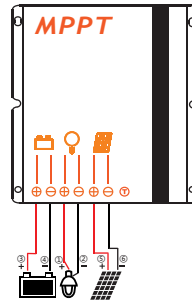

1. As the chart, connect the load with the corresponding brown(positive) and blue(negative) cables firstly, then seal them with tape.
2. Connect battery with the corresponding red(positive) and black(negative) cables. Load will be on after 5s.
3. Connect panel with the corresponding red(positive) and black/green( negative) cables, the load will be off after 5s, and the controller begins charging.
4. Refer to **11.LED indications and Faults & Alarms** to confirm the LED display status.

■ Make sure the wire length between battery and controller is as short as possible.

■ Recommended minimum wire size:  
20A: 4mm<sup>2</sup>; 30A: 6mm<sup>2</sup>

# Solar charge controller MPPT-DC series User Manual

## 4.2 Transportation mode

The controller is generally integrated with the lithium battery in the lithium battery pack for transport, if the controller works normal during transport, it will waste of energy and increase the transport risk. If the controller is set to transport mode, the load has no output, then the power consumption is reduced by about 60%, to avoid lithium battery voltage too low.

### 4.2.1 Open circuit protection

If the controller is only connected with the battery, but not connected with solar and load, the controller will enter transportation mode after 5 minutes.

### 4.2.2 Press the "Test" key in transport mode

Press the "Back" and "Backlight" key at the same time more than 3s, the remote controller will work in transport mode.

Press the "Test" key in the transport mode, the remote controller displays "Transport OK" and will beep a long sound, the controller enters into transport mode.



If the controller enters transport mode, the red LED will slow flash(0.2s on/5s off), the green and yellow led will be off and the remote control displays "Open CP".

### 4.2.3 Exit the transportation mode

When the load is properly connected, press the test key or connect the solar more than 1s during daytime, the transport mode will terminate and the controller will work normally.

## 5.Remote controller, Default setting

When MPPT-DC series controller is connected to the system, you can setting the controller with S/SG-Unit(SU/SG32) infrared remote controller, detailed setting operations, please read S/SG-Unit(SU/SG32) User Manual.

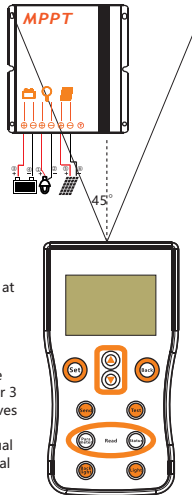

### Remark:

S-Unit:

Be sure to set only one controller at a time.

SG-Unit:

(1) It's ability to set up multiple controllers at the same time.

(2) The indicators and load will be turned off for 1 second and on for 3 seconds after the controller receives the parameters successfully(according to the actual current), and then return to normal status.

## 5.1 Test function

Pressing the "Test" key of SU/SG32, the controller will turn on load for 10s. 10s later the load will automatically turn off.

## 5.2 Read the parameters

Pressing the "Parameter" key of the SU/SG32 to read the setting parameters of the controller.

Num	Name	MPPT-DC Li
1	Time1	4H
2	Dim1	100%
3	Time2	0H
4	Dim2	100%
5	Time3	0H
6	Dim3	100%
7	Time4	0H
8	Dim4	0%
9	Time5	0H
10	Dim5	100%
11	D/N Thr	2.0V
12	D/N Dly	0min
13	Load I	0.3A
14	Dim Auto	Yes
15	Dim V	3.3V
16	Dim %	20%
17	3.2V LiFePO4	
18	CVT	3.6V
19	CVR	3.4V
20	LVD	2.6V
21	LVR	3.0V
22	0°C Chg	Yes

## 5.3 Read the running status

Pressing the "Status" key of the SU/SG32 to read the running status of the controller.

Num	Name	Name describe	Unit
	Status:	Charge	
1	Batt V	Battery voltage	V
2	Load I	Load current	A
3	Load V	Load voltage	V
4	PV V	PV voltage	V
5	PV I	PV current	A
6	Energy	Total generating capacity	AH
7	OD Times	Over discharge times	Times
8	FC Times	Fully charge times	Times
9	Day1-HV	A day ago highest voltage	V
10	Day1-LV	A day ago lowest voltage	V
11	Day2-HV	Two days ago highest voltage	V
12	Day2-LV	Two days ago lowest voltage	V
13	Day3-HV	Three days ago highest voltage	V
14	Day3-LV	Three days ago lowest voltage	V

# Solar charge controller MPPT-DC series User Manual

## 6.Starting up the controller

### 6.1 Self Test

As soon as the controller is connected to battery, it starts self test. Then the display changes to normal operation.

### 6.2 Battery Type

MPPT-DC series controller applies to single Lithium rechargeable battery.

### 6.3 0°C Charging Protection

"0°C Chg" can be set to "Yes", "Slow" or "No". When the controller detects that the ambient temperature is higher than 0°C, the charging function is normal. when the ambient temperature is low than 0°C, if the "0°C Chg" is set to "Yes", the charging function is normal, else if the "0°C Chg" is set to "slow", the max charging current is 20% of the rated current, else if the "0°C Chg" is set to "No", the controller does not charge the battery.

The user can select the appropriate charging method.

## 7. Streetlight Function

MPPT-DC Li series controller with advanced street light control function. The modes of lighting can be based on customer needs.

### 7.1 Dusk to Dawn (D2D)

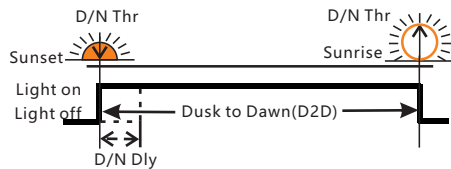

If "Time1" is set to "D2D", the controller works in dusk to dawn mode.

- 1.MPPT-DC Li series controller is set to D2D mode, the corresponding dimming setting is still valid.
2. If "Time1" is set to D2D mode, "Time4" can not be set to T0T mode.

### 7.2 Five-stage Night Mode

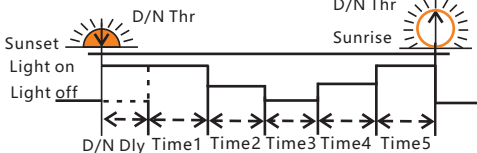

You can set the Time 1-5 and Dim 1-5 with SU/SG32.

### 7.3T0T mode(can set the load on time before morning coming)

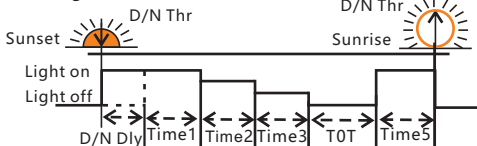

If "Time4" of the SU/SG32 is set to "T0T", this mode is T0T mode.

\* If Time4 is set to "T0T", Time1 can not set to "D2D".

## 8.LVD, LVR, Threshold, Dimming

### 8.1Low Voltage Disconnect(LVD)

Low voltage disconnect setting range: 2.4~4.0V

### 8.2Low Voltage Reconnect(LVR)

Low voltage reconnect setting range: 2.6~4.2V

- 1.If the controller goes into low voltage disconnect, it will restore only when the battery being recharged to the recovery voltage.
- 2.LVR should be higher than LVD at least 0.2V.

### 8.3 Day/Night Threshold, Day/Night Delay

The controller recognizes day and night based on the solar array open circuit voltage. This day/night threshold can be modified according to local light conditions and the solar array used.

Day/Night threshold setting range: 1.0~3.0V.

In the evening, when the solar array open circuit voltage reaches the setting day/night threshold, you can adjust the day/night delay time to make the load turn on a little later.

Day/Night delay time setting range: 0~30min.

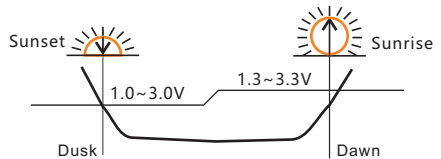

1. Day/Night threshold voltage should be set around 0.1 times of open circuit voltage.
- 2.Day/Night threshold voltage of load disconnect is 0.3V higher than the setting data, means the load will disconnect when the solar voltage at 1.3~3.3V.
- 3.The controller has an automatic day/night threshold adjustment function. If the lowest voltage of solar array is higher than the setting day/night threshold, the load has no output in first night, 24 hours later the controller can automatically adjust the day/night threshold to meet the requirements of lighting at night.

### 8.4 Auto Dimming

The "Dim Auto" item of SU/SG32 is set to "Yes", set "Dim V" and "Dim %" at the same time, press the "Send" key to set up the controller. when the battery voltage is lower than the voltage of "Dim V", it starts to dimming automatically. Battery voltage reduces per 0.1V, load current decreased according to the set of "Dim %", the minimum output current is 10% of the setting current.

- 1.If the controller is set to "Dim" or "Auto Dim", the minimum output power can be as low as 50mA.

# Solar charge controller MPPT-DC series User Manual

## 9. Safety Features

	Solar terminal	Battery terminal	Load terminal
Reverse polarity	Protected	Protected	Protected *1
Short circuit	Protected*1	Protected*2	Switches off immediately
Over current	—	—	Switches off with delay
Reverse Current	Protected	—	—
Over voltage	Max.25V <sup>3</sup>	Max. 10V <sup>4</sup>	—
Under voltage	—	—	Switches off
Over temp.	The controller cuts off the load if the temperature reaches the set value.		

\*1.When the PV doesn't charge, the controller will not be damaged if short-circuit just happened in the PV array.

**Warning: It is forbidden to short-circuit the PV array during charging .Otherwise, the controller may be damaged.**

\*2.Battery must be protected by fuse, otherwise battery will be damaged.

\*3.Please refer to "12.Technical Data" to get the max voltage of PV panel.

\*4.Please refer to "12.Technical Data" to get the max voltage of battery.



**Warning: The combination of different error conditions may cause damage to the controller.Always remove the error before you continue connecting the controller.**

## 10.Recommended connection of LED

Following connect ways is for the LED lights

(Vf: 2.9V~3.4V; I: 300mA, Power: 1W )

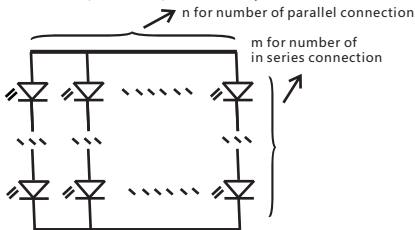

Output Voltage	Load Current	LED chips connection
12~34V	0.1~1.5A	M=4~10 N=1~5
	0.1~3A	M=4~10 N=1~10

## 11.LED indications and Faults & Alarms

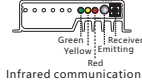
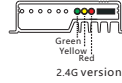

### 11.1LED Display Explanation

LED	Status	Function
Green LED	On	Solar panel is correctly connected, but not charged
	Fast flash(0.1/0.1s)	MPPT charging
	Slow flash(0.5/2s)	Charging
Yellow LED	Off	Over voltage protection
	On	Battery is normal
	Slow flash(0.5/2s)	Battery voltage is low
Red LED	Fast flash(0.1/0.1s)	Low voltage protection
	Off	Work normal
	On	The output power is 0.
	Slow flash(0.2/5s)	Open circuit or transport mode. *1
Red LED	Flash(0.5/0.5s)	Over temperature protection
	Fast flash(0.1/0.1s)	Short circuit or Over current protection *2

\*1.If the controller is in transport mode, the red LED is super slow flash(0.2s on/5s off), the green and yellow led is off.

\*2.Detailed fault information can be read by S-Unit remote controller.

### 11.2Faults & Alarms

Fault	Status	Reason	Remedy
Loads are not powered	Low volt. protection	Battery capacity is low	Load will be reconnected when battery is recharged
	Overcurrent, short circuit protection	Loads are over current or short circuit	Switch off all loads, remove short circuit, load will be reconnected after 1 minute automatically
	Over temp. protection	Controller temp. Is too high	Load reconnects after temp. reduces
High voltage at battery terminal	Over voltage protection	High battery voltage > (CVT+0.2V)	Check if other sources overcharge the battery. If not,controller is damaged.
		Battery wires or battery fuse damaged, battery has high resistance.	Check battery wires, fuse and battery.
Battery is empty after a short time	Low voltage protection	Battery has low capacity	Change battery
Battery can't be charged	Can not be charged	PV panel fault or reverse connection	Check panels and connection wires

# Solar charge controller MPPT-DC series User Manual

## 12. Technical Data

	Item	MPPT2050-DC32Li	MPPT3050-DC32LiG
Battery Parameters	Max Charging Current	20A	30A
	MPPT Charging Voltage	< Charging target voltage	
	Charging voltage target	3.0~5.0V(Programmable)	
	Charging voltage recovery	2.9~4.9V(Programmable)	
	Low voltage disconnect	2.4~4.0V(Programmable)	
	Low voltage reconnect	2.6~4.2V(Programmable)	
	Battery Type	Lithium	
	0°C Charging protection	Yes, Slow, No(Programmable)	
	Max volt on Bat. Terminal	10V	
Panel Parameters	Max volt on PV terminal	25V	34V*1
	Max input power	65W	100W
	MPPT tracking range	(Vb+1.0V) ~Voc*0.9 *2	
	Dusk/Dawn detect volt.	1.0~3.0V (Programmable)	
	Day/Night delay time	0~30min(Programmable)	
Load Parameters	Output Current	0.1~1.5A(Programmable)	0.1~3A(Programmable)
	Output Voltage	12~34V	
	Output power	1~25W	1~60W
	Min Current	50mA(Dimming)	
	Current precision	±2%	
	Dimming	0~100%(Programmable)	
	Auto dimming	Yes, No(Programmable)	
	Voltage of start dimming	2.8~Charging target voltage(Programmable)	
	Dimming percentage	5~40%(Programmable)	
		Max tracking efficiency	>99.9%
System Parameters	Max charge conversion	93.0%	95.0%
	Max LED driver efficiency	93.0%	95.0%
	Self consumption	<23mA@3.2V	50mA@3.2V
	Dimensions	85.8 * 81 * 23.1mm	112 * 76 * 30mm
	Weight	280g	450g
	Ambient temperature	-35~+60°C	
	Ambient humidity	0~100%RH	
	Protection degree	IP67	
	Max Altitude	4000m	

\*1.This value represents the maximum voltage of the solar panel at the minimum operating ambient temperature.

\*2.Voc means the open circuit voltage of the solar panel.

\*3.The product without tail is infrared communication,Model name + "G", means 2.4G communication.