

Epoch Series Pure Sine Wave Inverter

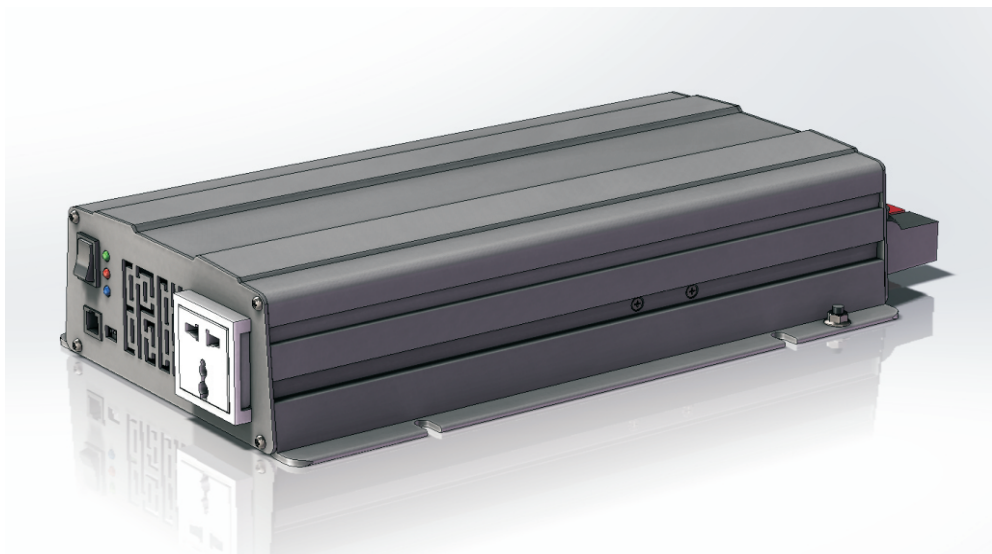

User Manual

User Manual_Epoch series_ML
CE, Rohs, ISO9001:2015
Subject to change without notice!

Contents

1.Safety instructions and waiver of liability	1
1.1 Safety Instructions.....	1
1.2 Liability Exclusion.....	1
1.3 Safety precautions.....	1
2.Overview	2
3.Dimensions	3
4.Structure & Operations	4
4.1 Structure & Characteristics.....	4
4.2 RS232.....	4
4.3 Mode Switch.....	4
5.Desinations of Models	4
6.Installation	5
6.1 Installation Notes.....	5
6.2 Mounting Location Requirements.....	6
6.3 Wiring Specifications.....	6
7.LED	7
8.Troubleshooting, Protections and maintenance	7
8.1 Protection.....	7
8.2 Troubleshooting.....	8
8.3.Maintenance.....	8
9. Technical Data	9

Dear Clients,

Thank you for purchasing our Epoch Series inverter. Your support and trust in us are much appreciated. Please take time to read this manual, this will help you make full use of the many advantages this inverter. This manual presents important recommendations for installing and operating. Read it with special care in your own interest and please pay attention to the safety recommendations herein indicated.

1, Safety instructions and waiver of liability

1.1 Safety Instructions

Please reserve this manual for future review.

The following symbols are used throughout this manual to indicate potentially dangerous conditions or mark important safety instructions. Please take care when meeting these symbols.



WARNING: Indicates a potentially dangerous condition. Use extreme caution when performing this task.



CAUTION: Indicates a critical procedure for safe and proper operation of the inverter.



CAUTION:

- 1) There are no user serviceable parts inside the inverter. Do not disassemble or attempt to repair the inverter.
- 2) Keep children away from batteries and the charge inverter.

1.2 Liability Exclusion

The manufacturer shall not be liable for damages, especially on the battery, caused by use other than as intended or as mentioned in this manual or if the recommendations of the battery manufacturer are neglected. The manufacturer shall not be liable if there has been service or repair carried out by any unauthorized person, unusual use, wrong installation, or bad system design.

1.3 Safety precautions

After receiving the inverter, please check the product condition first, if there is any damage occurred during shipping, please contact the transportation company or us in time.



CAUTION: The installation of the system must be done by professional technicians.



CAUTION: Make sure there isn't any electrical arcing danger around the operation area before installation.



CAUTION: Connect the inverter to the battery is highly recommended; the minimum capacity (Ah) of the battery should be 5 times of the inverter rated output power (P), which means $Ah=5 \times (P/V)$.



WARNING: This off-grid inverter may be damaged if connected to the utility or electrical source.



WARNING: Only a single inverter is allowed to operate at a time. Do not connect multiple inverters in series or parallel. It may cause the inverter damaged.



WARNING: The AC output with high voltage during the inverter operation, do not touch any connection point, it may cause danger.



WARNING HOT SURFACE: Do not touch the inverter when it's operating, the inverter case of the inverter will generate a high value of heat, also keep distance to the material or equipment affected by high temperature.



CAUTION: Do not open the inverter external case or try any operation when the inverter is on.



WARNING: The following operations may cause electric arc, fire or explosion. When a fault occurs, please ask trained technicians to solve the issue. Any incorrect operation would cause a serious accident.

- Touch the wire end, which hasn't been insulation treated, may cause electric shock.
- Touch the wiring copper row, terminals or internal devices, which may cause electric shock.
- The power cable connection is loose.
- Screw or other components inadvertently falls into the inverter.
- Incorrect operation by untrained non-professional people.



WARNING: Do not touch or open the external case!

- The inverter is allowed to restart after removing the fault which affects the safety performance of the inverter.
- No maintenance parts are included in the inverter, please contact our customer service department for required maintenance service.

2, Overview

Thanks for purchasing Epoch series inverters. The product is a pure sine wave inverter which can convert 12V/24Vdc to 220V/230Vac(or110V/120Vac) 50/60Hz based on full digital and intelligent design. It features high reliability high efficiency, full protection functions, easy installation and operation. The inverter can be applied in many fields, such as household appliances, electric tools and industrial devices etc, especially for solar photovoltaic power system.

- Complete isolation-type inverter technology.
- Adoption of advanced SPWM technology, pure sine wave output.
- Dynamic current loop control technology to ensure inverter reliable operation.
- Wide DC input voltage range.
- Low output harmonic distortion($THD \leq 2\%$)
- LED indicators for input voltage range, normal output & failure state.
- Extensive protections: short-circuit, overload, under/over input voltage, over-temperature, and inverter's inner fault identification protections.
- The output voltage and frequency can be switched.
- Optional energy SAV mode(saving mode).
- Wide working temperature range (industrial level).
- Continuous operation at full power.

3, Dimensions

Unit: mm

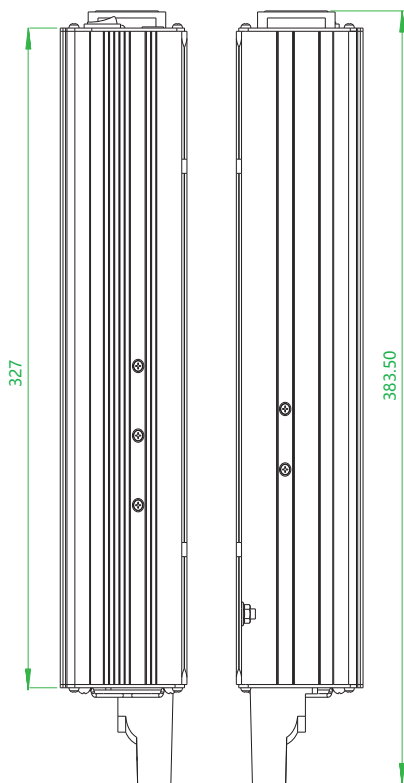
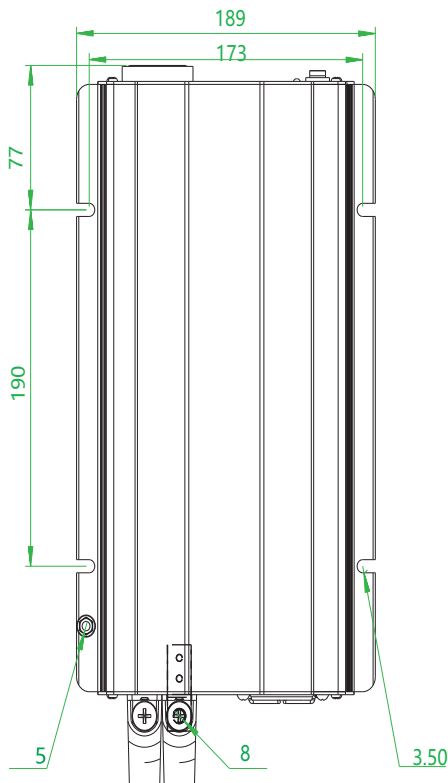
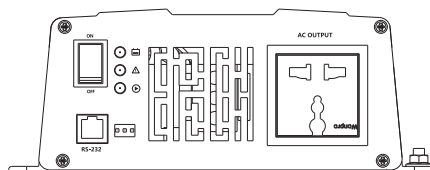
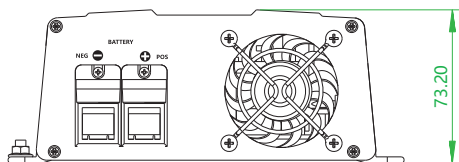

3

4, Structure & Operations

4.1 Structure & Characteristics

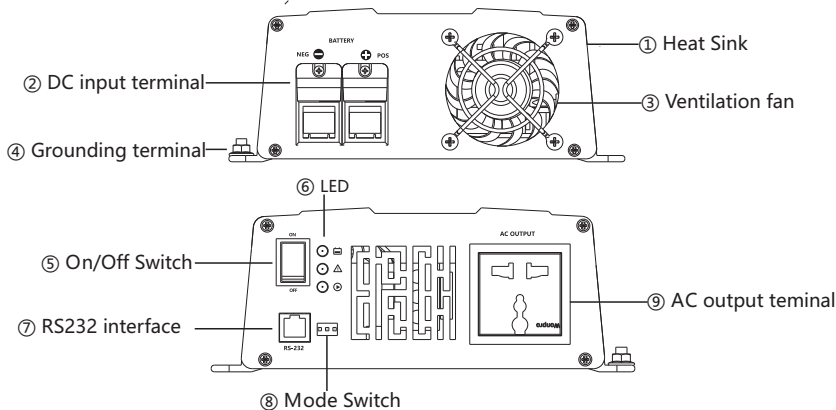

Ventilation fan: When the temperature of the radiator is greater than 40 °C, the fan will be turned on; otherwise, the fan will be turned off.

4.2 RS232

The inverter is equipped with a RS232 port with RJ11 sockets, the RJ11 interface is defined as follows:

Pin No.	Definition
1	R×D
2	R×D
3	T×D
4	T×D
5	GND
6	GND

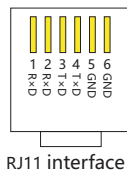

4.3 Mode Switch

The output voltage, power and frequency of the inverter can be modified flexibly according to the demand.

SAV/NOR: NOR is normal output mode, standby power < 8W; SAV is power saving mode, standby power < 5W. When the switch is on "SAV" side, the inverter will enter into the Saving Mode. It will shut off the output if the output power is less than 20W. Then restart and detect the power of the load again after 10s. If the load is more than 20W, the inverter will turn on the output. Otherwise it will shut off output again. It cycles like this. So please don't use the saving mode if the load is smaller than 20W.

50/60Hz: Output frequency is adjustable.

220/230Vac(or110/120Vac): Output voltage is adjustable.

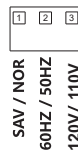
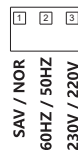

5.Desinations of Models

EP 1000-22X

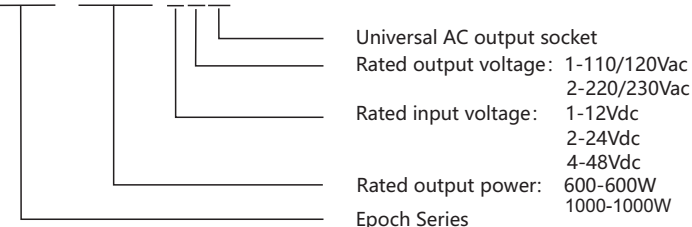

6, Installation



CAUTION: Please read the manual carefully to get familiar with the installation steps before installation.

6.1 Installation Notes

- ① Be very careful when installing the batteries, especially flooded lead-acid batteries. Please wear eye protection, and have fresh water available to rinse if any contact with battery acid.
- ② Keep the battery away from any metal objects, which may cause a short circuit of the battery.
- ③ Loose connections and corroded wires may result in high heat that can melt wire insulation, burn surrounding materials, or even cause a fire. Ensure tight connections and use cable clamps to secure cables and prevent them from swaying in motion.
- ④ Select the system connection cables according to the current density no higher than 3.5A/mm².
- ⑤ For outdoor installation, keep out of the direct sunshine and rain infiltration.
- ⑥ Please do not install the inverter in humid, greasy, flammable, explosive, dust accumulative, or other severe environments.
- ⑦ AC output is a high voltage, and please do not touch the wiring connection.
- ⑧ When the fan is working, and please do not touch it to avoid injury.



WARNING: Make sure the inverter is clean and no electrical connection before installation.



CAUTION: To avoid the danger of heat accumulation caused by the loose connection, please ensure all the cable connections are tight.



CAUTION: Please connect the inverter case to the ground and ensure the sectional area of the connection cable is not less than 4mm².



CAUTION: Follow the parameter setting requirements to set the DC input voltage, higher or lower may cause the inverter down or even broken.



CAUTION: The cable between battery and inverter should be less than 3meters, otherwise, please reduce the current density.



CAUTION: A fuse or breaker is recommended between battery and inverter, also the rated current of the fuse or breaker should be 1.25*Rated current of battery.



CAUTION: Keep the inverter away from the flooded lead-acid battery because the sparkle of the terminals may ignite the hydrogen released by the battery.



WARNING: Only the load is allowed to connect to the AC output terminal, do not connect it to power supply or utility, which may cause the inverter damaged, also please shut off the inverter before wiring.



WARNING : Do not directly connect the battery charger or similar devices to the input terminal of the inverter.

6.2 Mounting Location Requirements

Do not subject the inverter to direct sunlight or any other heat sources. Protect the inverter from any dust, dirt and moisture. Mount it flat to a vertical wall. Must be a non-flammable material. Maintain a minimum clearance of 15 cm below and around the inverter to ensure unhindered air circulation.



CAUTION: The inverter shall be cooling through case if installed in a closed box.

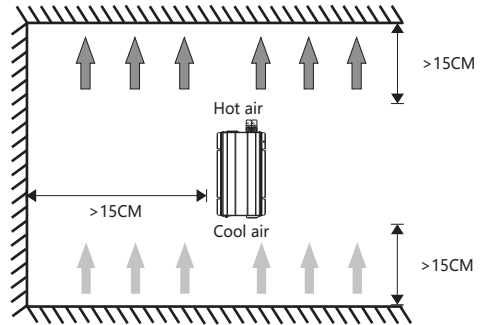

6.3 Wiring Specifications

We strongly recommend connecting a fuse directly to the battery terminal to protect from any short circuit in the battery circuit. Never touch uninsulated cables (ends), only use electric insulated tools, and make sure that the wires are suitable.

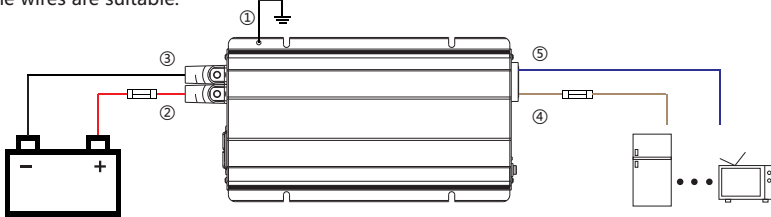

WARNING : The AC equipment shall be determined by the continuous output power of the inverter, but the surge power must be lower than the instantaneous surge power of the inverter.



CAUTION: 1.The switch of the inverter is OFF before wiring.
2.Do not close the circuit breaker or fuse and make sure that the leads of "+" and "-" poles are correctly connected while wiring the inverter.



CAUTION: A fuse which current is 12.5*Select the maximum battery current, it must be installed on the battery side with a distance from the battery not greater than 150mm.

Please confirm that the inverter is off before wiring.

1st step: Grounding: Connect the ground terminal of the inverter to the ground

2nd step: Loads: Connect the load to the inverter output (universal socket).

3rd step: Battery





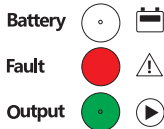

Connect the battery cables observing the correct polarity to the input terminal of the Inverter(make sure you identify the battery marking/symbol on the inverter casing!) . Pay greatest attention to polarity. Never, ever invert the plus+ and minus- poles).

4th step: Power on the inverter

- 1) Tighten all cables connected to the inverter and remove all the remains around the inverter (leaving a void of minimum 15 cm);
- 2) Switch on the input breaker or the fuse between inverter and battery;
- 3) Turn on the power switch to start the inverter, Green indicator on solid, and the AC output is normal;
- 4) Turn on the load one by one, and check the operation status of both inverter and load;
- 5) If the fault indicator is red and the buzzer alarms when turn on the inverter, please switch off the loads and inverter immediately. Refer to 8.2 Troubleshooting. After troubleshooting, please follow the above steps and operate again.

7, LED



	Led	Status	Function
Battery  	Battery LED (Tri-color)	Red: On	$V_{bat} < 12(@12V)$, $V_{bat} < 22V(@24V)$
		Green: On	$12 \leq V_{bat} < 14.5V(@12V)$, $22 \leq V_{bat} < 23V(@24V)$
		Yellow: On	$14.5 \leq V_{bat} < 15.5(@12V)$, $23 \leq V_{bat} < 31V(@24V)$
		Red: Flash(1s/1s)	Over temperature protection(OTP)
		Red: Flash(0.25s/0.25s)	Low voltage protection(LVD)
		Red: Flash(3s/3s)	Over voltage protection(OVP)
		Red: Flash(4s/4s)	LVD+OTP
		Red: Flash(6s/6s)	OVP+OTP
Fault  	Fault LED (Red)	Flash(0.25s/0.25s)	Inverter is about to be protected under heavy load
		On	Over load, Short-circuit, No output in SAV mode
Output  	Output LED (Green)	On	Working normally
		Off	Working abnormally
	Buzzer	Ring	Hardware Protection

8, Troubleshooting, Protections and maintenance

8.1 Protection

- **Input reverse polarity protection**
 It is recommended that the battery be connected in series with fuse(60A) prevent the internal components of inverter from being damaged.
- **Over voltage protection**
 When the input voltage exceeds 16/31V, the inverter will stop charging to protect the battery from overcharging damage. When the voltage is reduced to 14.5/29V, it will resume normal operation.
- **Low voltage protection**
 When the input voltage is lower than 10.8/21V, the inverter will stop discharging to protect the battery from over discharging damage. When the voltage rises above 12.5/25V, it resumes working.
- **Load Short circuit Protection**
 Once the load short circuit happens, the load short circuit protection will trigger automatically. (When the overload protection happens, the AC output will recover automatically for 3 times(recover after 5s). After then the AC output will not recover automatically after 3 times attempt until restarting the inverter.)
- **Overload protection**
 Once the output power is higher than rated power, the over load protection will trigger automatically. (When the overload protection happens, the AC output will recover automatically for 3 times(recover after 5s). After then the AC output will not recover automatically after 3 times attempt until restarting the inverter.)
- **Over Temperature Protection**
 The inverter detects the internal temperature through internal sensor, when the temperature exceeds 95°C, it will stop working and resume after temperature returns to 70°C.

 **When the overload protection happens 4 times, the AC output do not have the recover automatically function.**

8.2 Troubleshooting



WARNING: Do not try to repair or maintain the inverter by own, and it may cause danger.

Faults	Reason	Troubleshooting
Battery LED is red, and flash(0.25S/0.25S)	Low DC input voltage	Measure the DC input voltage if the voltage is lower than 10.8/21V. Adjust the input voltage to recover normally.
Battery LED is red, and flash(3S/3S)	High DC input voltage	Measure the DC input voltage if the voltage is lower than 16/31V. Adjust the input voltage to recover normally.
Battery LED is red, and flash(1S/1S)	Over temperature	Improve ventilation quality, do not block the vent, reduce the temperature around the power supply, restart the device after the temperature reaches 70°C, if still not working, please derate the power for use.
Fault LED flash (0.25S/0.25S)	Inverter is about to be protected under heavy load	Check if the load exceeds the rated output power of the inverter.
Fault LED is on	Short circuit and over current in loading	Check that if the output is overloaded, if the output line is shorted, or if the dial switch is SAV mode. Clear the fault and restart the inverter to resume normal operation.
Output LED is off	Inverter is abnormal	Check input and output

8.3 Maintenance

For best system performance, the following inspections and maintenance tasks are recommended to be carried out for at least two times a year.

- Make sure no block on air-flow around the inverter. Clear up any dirt and fragments on radiator.
- Check all the naked wires to make sure insulation is not damaged. Repair or replace some wires if necessary.
- Check and confirm that LED is consistent with required. Pay attention to any troubleshooting or error indication. Take corrective action if necessary.
- Make sure all system components are effectively and tightly connected to ground.
- Check all terminals for any corrosion signs, damaged insulation, increased temperature or carbonization/discolored signs.
- Check for any dirt and any corrosion signs. Implement corrections actions as early as possible.



WARNING : Risk of electric shock!

Make sure that all the power has been turned off and standing still for 20 minutes before above operations, and then follow the corresponding inspections and operations.

9, Technical Data

Item	EP1000-21X	EP1000-22X	EP600-12X
Electrical Parameters			
Input rated voltage	24V		12V
Input voltage range	21~30.5Vdc		10.8~15.5Vdc
No load current	≤0.5A@24Vdc		≤0.9A@12Vdc
Output voltage	110/120Vac	220/230Vac	
Continuous power	1000W		600W
Power 60sec	1100~1300W		750~900W
Power 10sec	/		900~1200W
Power 1.5sec	>1300W		>1200W
Surge Power	<2000W		<1350W
Output Mode	Single-phase electricity		
Output wave	Pure sine wave		
Frequency	50/60Hz		
Diatortion THD	THD≤2%(Resistive load)		
Efficiency at full load ^{*1}	>92%		>92.5%
Max. efficiency ^{*2}	≥93%	≥94%	≥93%
SAV mode	0.2A; The load is detected every 10sec, if the output power is greater than 20W, it will output continuously		Nothing
DC current	50A		
Shutdown status	<1mA		
Fuse	90A		
Environment Parameters			
Dimension	383*189*73mm		
Hole Size	φ7mm		
Weight	3.1Kg	2.9Kg	
Working temperature	-20°C~+50°C		
Storage temperature	-35°C~+70°C		
Humidity	<95%(N.C.)		
Altitude	<5000m (Derating to operate according to IEC62040 at a height exceeding 1000m)		
Other Parameters			
Insulation	Between AC output/DC input terminals and metal case: ≥550MΩ		
Dielectric strength	Between AC output/DC input terminals and metal case: Test voltage AC1500V, 1min		
Application	Household appliances, cars, solar system and so on		

*1.Resistive at full load is continuous output power when the DC input is the rated voltage(@25°C);

*2.The efficiency is referred to the max. power when connected with different load under the rated DC input voltage.

*3.Select appropriate inverters according to voltage standards of different countries